



訂購碼 How to Order

FAZH **07** **B** **S** - **06** - **06**
 FAZH **07** **D** **S** - **01** - **01** - **01**

① 噴嘴直徑(mm) Nozzle diameter(mm)		② 最高真空度 Max.vacuum pressure		③ (注)SUP. 港口連接口徑 (Note)SUP. Port size			④ (注)VAC. 港口連接口徑 (Note)VAC. Port size			⑤ (注)EXH. 港口連接口徑 (Note)EXH. Port size		
記號 Symbol	尺寸 Size	記號 Symbol	形式 Style	記號 Symbol	尺寸 Size	形式 Style	記號 Symbol	尺寸 Size	形式 Style	記號 Symbol	尺寸 Size	形式 Style
05	0.5	S	-88kPa	06	Φ6	快換接頭 One-touch	06	Φ6	快換接頭 One-touch	06	Φ6	快換接頭 One-touch
07	0.7	L	-48kPa	08	Φ8	快換接頭 One-touch	10	Φ10	快換接頭 One-touch	08	Φ8	快換接頭 One-touch
10	1.0			10	Φ10	快換接頭 One-touch	12	Φ12	快換接頭 One-touch	10	Φ10	快換接頭 One-touch
13	1.3			12	Φ12	快換接頭 One-touch	16	Φ16	快換接頭 One-touch	12	Φ12	快換接頭 One-touch
15	1.5			01	Rc 1/8	螺紋擰入 Screw-in	01	Rc 1/8	螺紋擰入 Screw-in	16	Φ16	快換接頭 One-touch
18	1.8			02	Rc 1/4	螺紋擰入 Screw-in	02	Rc 1/4	螺紋擰入 Screw-in	01	Rc 1/8	螺紋擰入 Screw-in
20	2.0			03	Rc 3/8	螺紋擰入 Screw-in	03	Rc 3/8	螺紋擰入 Screw-in	02	Rc 1/4	螺紋擰入 Screw-in
							04	Rc 1/2	螺紋擰入 Screw-in	03	Rc 3/8	螺紋擰入 Screw-in
										04	Rc 1/2	螺紋擰入 Screw-in

技術規格 Specifications

型號 Model	噴嘴直徑 Nozzle diameter Φmm	主體形式 Body style	最高真空度kPa Max.vacuum pressure(kpa)		最大真空流量l/min Max.vacuum flow l/min		空氣消耗量 Air consumption l/min	連接形式(快換接頭/螺紋擰入) Connection(One-touch/Screw-in)		
			S型 S style	L型 L style	S型 S style	L型 L style		S型/L型 S style/L style	SUP	VAC
FAZH05B□	0.5	盒型 (內置消聲器) Box style (Built-in silencer)	-88	-48	5	9	13.5	Φ6/Rc1/8	Φ6/Rc1/8	---
FAZH07B□	0.7				12	22	23.5			
FAZH10B□	1.0				24	34	46			
FAZH13B□	1.3				40	75	78			
FAZH05D□	0.5	直接配管型 (無消聲器) Body ported style (without silencer)	-88	-48	7.5	9	13.5	Φ6/Rc1/8	Φ6/Rc1/8	Φ6/Rc1/8
FAZH07D□	0.7				12	22	23.5			
FAZH10D□	1.0				24	34	46			
FAZH13D□	1.3				40	75	78			
FAZH15D□	1.5	直接配管型 (無消聲器) Body ported style (without silencer)	-88	-53	60	80	97	Φ10/Rc1/4	Φ12/Rc3/8	Φ12/Rc3/8
FAZH18D□	1.8				70	110	150	Φ12/Rc3/8		
FAZH20D□	2.0				85	140	185	Φ12/Rc3/8	Φ16/Rc1/2	Φ16/Rc1/2

*Supply pressure:4.5bar

表① 連接形式的組合 Table Combination of connection

主體形式 Body		SUP	VAC	EXH
盒型 (內置消聲器) Box style (Built-in silencer)	①	快速接頭 One-touch	快速接頭 One-touch	---
	②	快速接頭 One-touch	螺紋擰入 Screw-in	---
	③	螺紋擰入 Screw-in	螺紋擰入 Screw-in	---
直接配管型 (無消聲器) Body ported style (without silencer)	①	快速接頭 One-touch	快速接頭 One-touch	快速接頭 One-touch
	②	快速接頭 One-touch	螺紋擰入 Screw-in	快速接頭 One-touch
	③	螺紋擰入 Screw-in	螺紋擰入 Screw-in	螺紋擰入 Screw-in

表② 連接口徑 Table port size

型號 Model	SUP	VAC	EXH
FAZH05B			
FAZH07B	Φ6/Rc1/8	Φ6/Rc1/8	---
FAZH10B			
FAZH13B	Φ8/Rc1/8	Φ10/Rc1/4	
FAZH05D	Φ6/Rc1/8	Φ6/Rc1/8	Φ6/Rc1/8
FAZH07D			
FAZH10D	Φ6/Rc1/8	Φ6/Rc1/8	Φ8/Rc1/8
FAZH13D	Φ8/Rc1/8	Φ10/Rc1/4	Φ10/Rc1/4
FAZH15D	Φ10/Rc1/4	Φ12/Rc3/8	Φ12/Rc3/8
FAZH18D	Φ12/Rc3/8		
FAZH20D	Φ12/Rc3/8	Φ16/Rc1/2	Φ16/Rc1/2

外形尺寸(mm) Dimensions (mm)

盒型(內置消聲器)Box style (Built-in silencer)

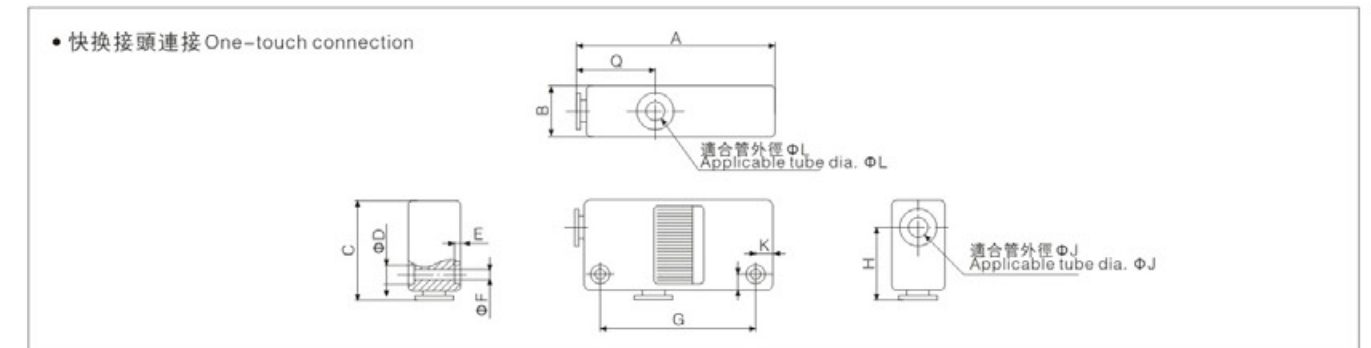

型號 Model	A	B	C	D	E	F	G	H	Q	L	K	J
FAZH05B-06-06	60	16	31	5.8	2	3.2	47	22	24	6	5	6
FAZH07B-06-06	60	16	31	5.8	2	3.2	47	22	24	6	5	6
FAZH10B-06-06	63	18	32	5.8	2	3.2	50	23	26	6	5	6
FAZH13B-08-10	78	23	38.5	7.5	3	4.2	61	27.5	28	10	7	8

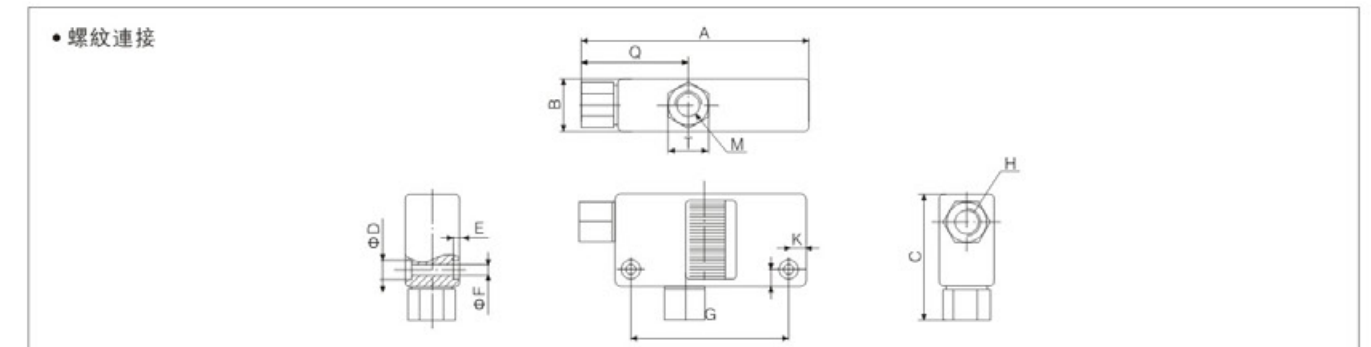

型號 Model	A	B	C	D	E	F	G	H	Q	M	K	T
FAZH05B-01-01	67.5	16	38.5	5.8	2	3.2	47	Rc1/8	31.5	Rc1/8	5	12
FAZH07B-01-01	67.5	16	38.5	5.8	2	3.2	47	Rc1/8	31.5	Rc1/8	5	12
FAZH10B-01-01	70.5	18	39.5	5.8	2	3.2	50	Rc1/8	33.5	Rc1/8	5	12
FAZH13B-01-02	86.5	23	50	7.5	3	4.2	61	Rc1/8	36.5	Rc1/4	7	14

直接接管型(無消聲器)Body ported style(without silencer)

• 快換接頭連接
One-touch connection

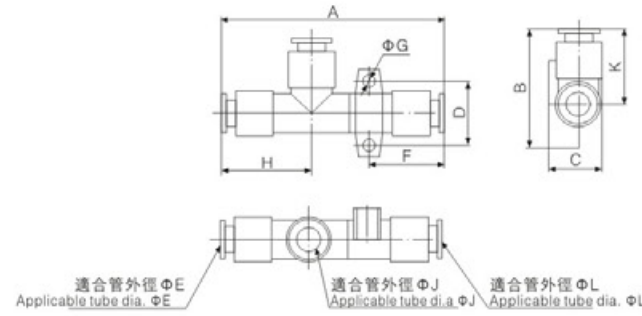

型號 Model	A	B	C	D	E	F	G	H	L	K	J
FAZH05D-06-06-06	58.5	34	14.2	17	6	21	3.2	24	6	22	6
FAZH07D-06-06-06	61	34	14.2	17	6	22	3.2	24	6	22	6
FAZH10D ^S -06-06-08	⁶⁶ / ₇₀	37	17.2	20	6	24.5	4.2	26	8	23	6
FAZH13D ^S -08-10-10	⁷⁴ / _{79.5}	42.5	20	22	8	27	4.2	28	10	27.5	10
FAZH15D-10-12-12	93.3	47	22.5	27	10	32.8	4.2	31.5	12	29.5	12
FAZH18D-12-12-12	114	41	21	10	12	50	3.5	35.5	12	30.5	12
FAZH20D-12-16-16	124.6	46	27	12	12	54.3	3.5	38.5	16	32.7	16

• 螺紋連接
Screw-in connection

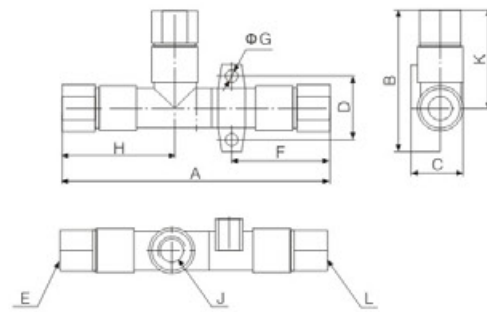

型號 Model	A	B	C	D	E	F	G	H	L	K	J
FAZH05D-01-01-01	73.5	41.5	14.2	17	Rc1/8	28.5	3.2	31.5	Rc1/8	22	Rc1/8
FAZH07D-01-01-01	76	41.5	14.2	17	Rc1/8	29.5	3.2	31.5	Rc1/8	22	Rc1/8
FAZH10D ^S -01-01-01	⁸² / ₈₆	44.5	17.2	20	Rc1/8	33	4.2	33.5	Rc1/8	23	Rc1/8
FAZH13D ^S -01-02-02	^{94.5} / _{99.5}	54	20	22	Rc1/8	38.5	4.2	36.5	Rc1/4	27.5	Rc1/4
FAZH15D-02-03-03	116.5	58.5	22.5	27	Rc1/4	44.5	4.2	43	Rc3/8	29.5	Rc3/8
FAZH18D-03-03-03	133	52.5	21	10	Rc3/8	57.5	3.5	47	Rc3/8	30.5	Rc3/8
FAZH20D-03-04-04	151	61	27	12	Rc3/8	69.3	3.5	50	Rc1/2	32.7	Rc1/2

不同真空度(-kPa)的真空流量(l/min)/Vacuum flow (l/min) at different vacuum levels(-kPa)

型號 Model	-kPa	供氣壓力 Air supply pressure	空氣消耗量 Air consumption	0	10	20	30	40	50	60	70	80	最大真空度 Max.vacuum level
FAZH05S	4.5 bar	4.5 bar	13.5 l/min	5	4.5	4.1	3.8	3.3	2.3	1.6	0.9	0.3	-88kPa
FAZH07S			23.5 l/min	12	11	10	9	8	7	5.5	2.1	0.8	
FAZH10S			46 l/min	24	23	20.5	17.5	13	11.5	9.5	7	2.5	
FAZH13S			78 l/min	40	35	32.5	28	23	19.5	13	9	4.5	
FAZH15S			97 l/min	60	52.5	45.5	38	28.5	20.5	15.5	11.5	5	
FAZH18S			150 l/min	70	62	52	45	38	26	22	16.5	8.5	
FAZH20S			185 l/min	85	76	67	58	47.5	38	33.5	19	12	

不同真空度(-kPa)的抽氣時間(s/l)Evacuation time (s/l) to reach different vacuum levels(-kPa)

型號 Model	-kPa	供氣壓力 Air supply pressure	空氣消耗量 Air consumption	10	20	30	40	50	60	70	最大真空度 Max.vacuum level
FAZH05S	4.5 bar	4.5 bar	13.5 l/min	0.89	1.7	3.2	5	7.8	12	19	-88kPa
FAZH07S			23.5 l/min	0.37	1	1.9	3	5.4	6.7	15	
FAZH10S			46 l/min	0.25	0.6	1.25	2	2.9	4.2	6.5	
FAZH13S			78 l/min	0.1	0.27	0.53	1	1.75	4.6	7.3	
FAZH15S			97 l/min	0.04	0.21	0.35	0.63	1.23	4.1	7.3	
FAZH18S			150 l/min	0.02	0.15	0.29	0.46	0.78	1.38	3.51	
FAZH20S			185 l/min	0.02	0.12	0.21	0.34	0.55	0.85	1.58	

• FAZH05S

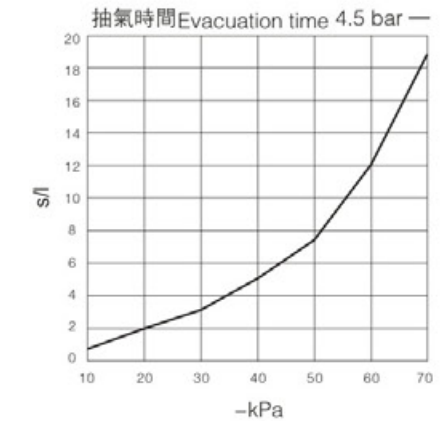
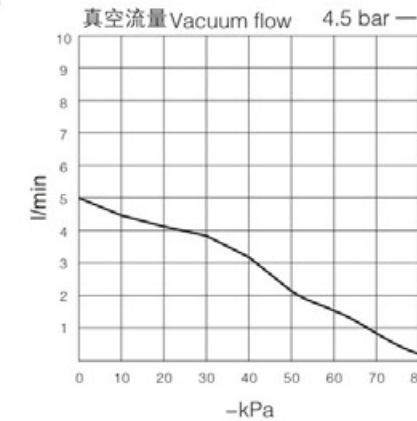

• FAZH07S

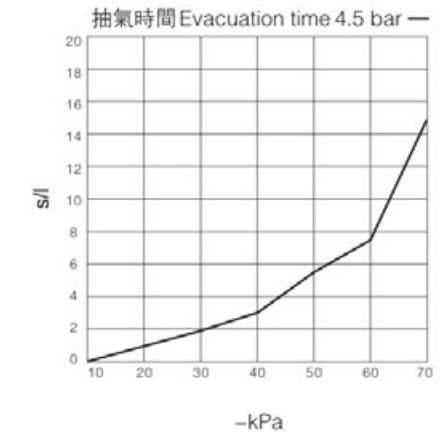
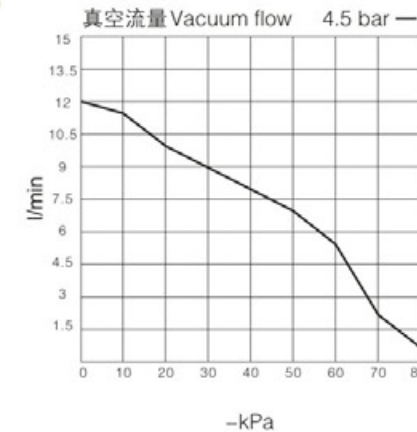

•FAZH10S

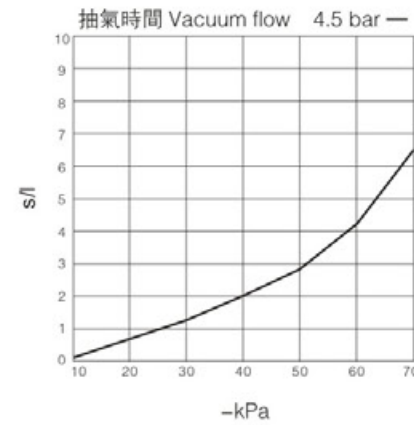
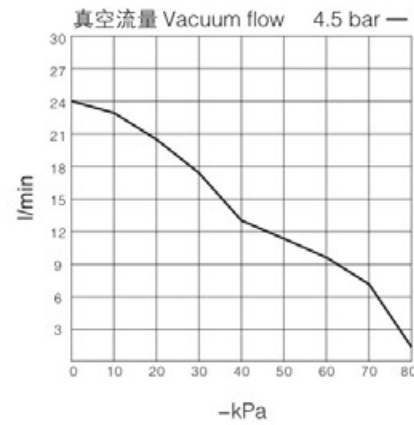

•FAZH13S

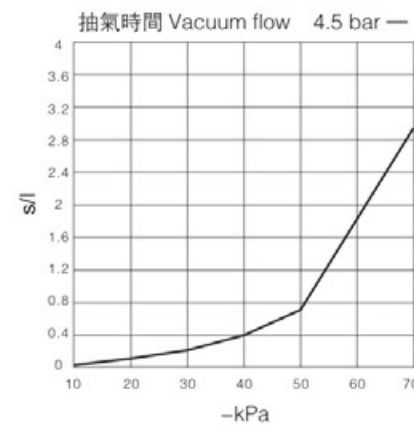
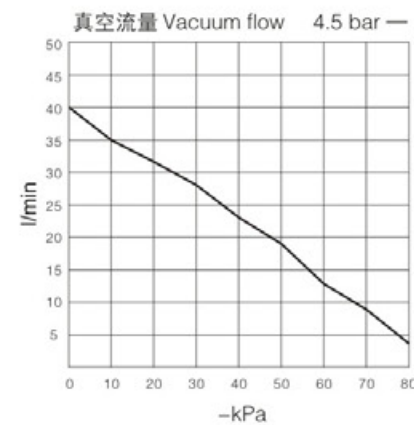

•FAZH15S

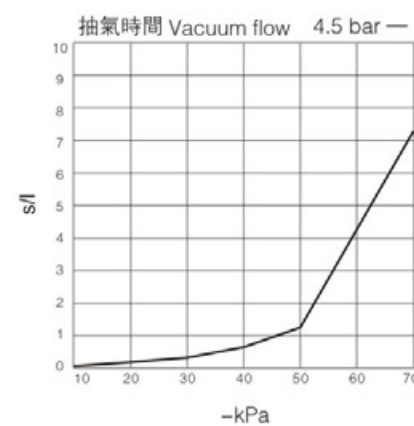
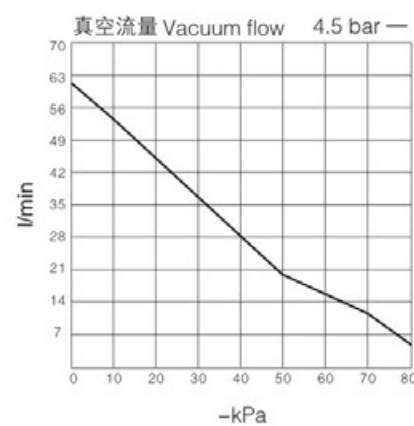

•FAZH18S

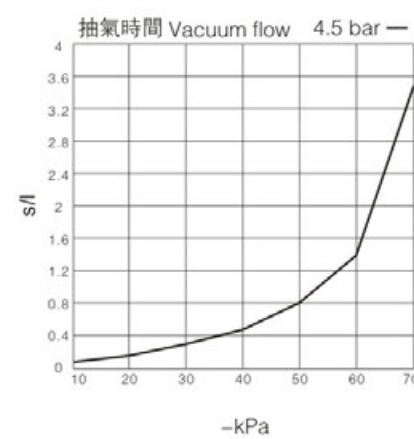
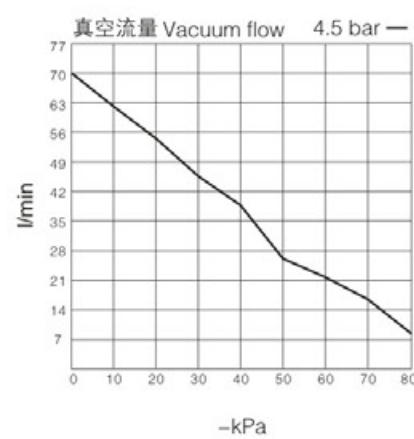

•FAZH20S

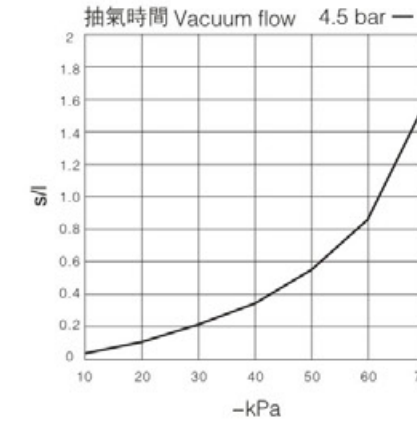
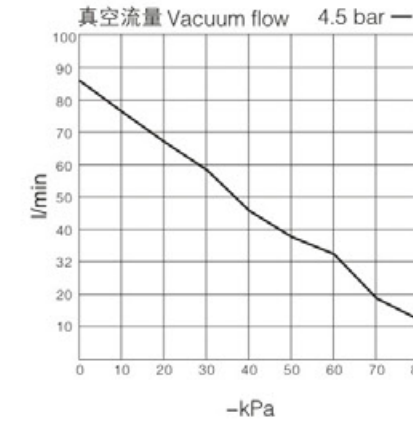

不同真空度(-kPa)的真空流量(l/min) Vacuum flow (l/min) at different vacuum levels (-kPa)

型號 Model	-kPa	供氣壓力 Air supply pressure	空氣消耗量 Air consumption	0	10	20	30	40	45	最大真空度 Max.vacuum level
FAZH05L	4.5 bar	4.5 bar	13.5 l/min	9	8	7	6	3	1.9	-48kPa
FAZH07L			23.5 l/min	22	21	20.5	15.5	10.5	6.8	
FAZH10L			46 l/min	34	32	26	19	12	8	
FAZH13L			78 l/min	75	72	65	43	19	9	

型號 Model	-kPa	供氣壓力 Air supply pressure	空氣消耗量 Air consumption	0	10	20	30	40	50	最大真空度 Max.vacuum level
FAZH15L	4.5 bar	4.5 bar	97 l/min	80	72	60	45	36.5	16	-53kPa
FAZH18L			150 l/min	110	105	95	80	55	30	
FAZH20L			185 l/min	140	130	120	100	80	62	

不同真空度(-kPa)的抽氣時間(s/l)

型號 Model	-kPa	供氣壓力 Air supply pressure	空氣消耗量 Air consumption	10	20	30	40	45	最大真空度 Max.vacuum level
FAZH05L	4.5 bar	4.5 bar	13.5 l/min	0.49	1.5	2.9	5.1	7.2	-48kPa
FAZH07L			23.5 l/min	0.28	0.75	1.5	2.5	3.5	
FAZH10L			46 l/min	0.14	0.4	0.81	1.4	1.8	
FAZH13L			78 l/min	0.04	0.12	0.24	0.62	2.4	

型號 Model	-kPa	供氣壓力 Air supply pressure	空氣消耗量 Air consumption	10	20	30	40	50	最大真空度 Max.vacuum level
FAZH15L	4.5 bar	4.5 bar	97 l/min	0.03	0.15	0.23	0.4	0.92	-53kPa
FAZH18L			150 l/min	0.02	0.10	0.18	0.32	0.67	
FAZH20L			185 l/min	0.01	0.08	0.14	0.2	0.3	

•FAZH05L

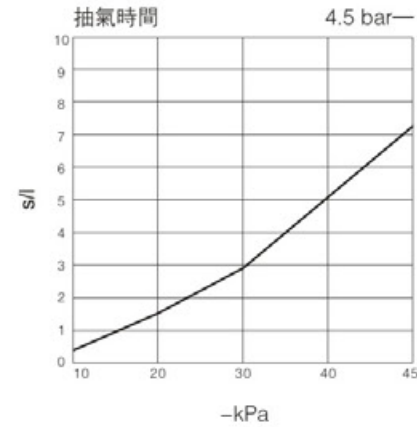
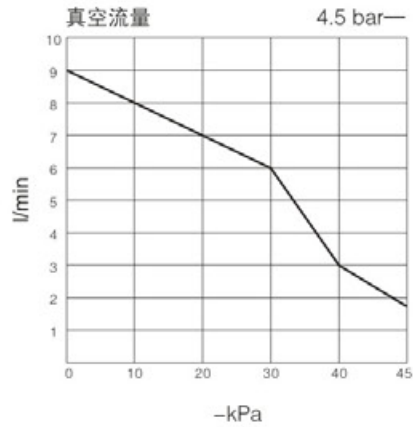

•FAZH07L

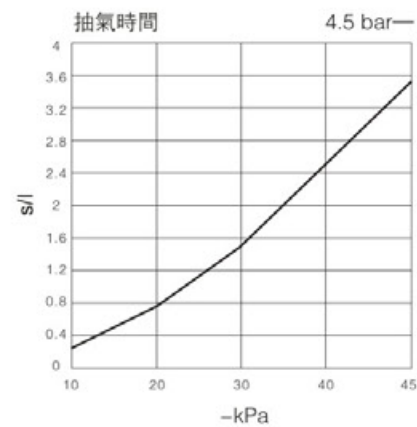
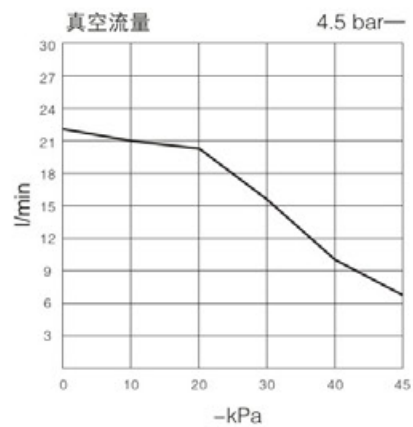

•FAZH10L

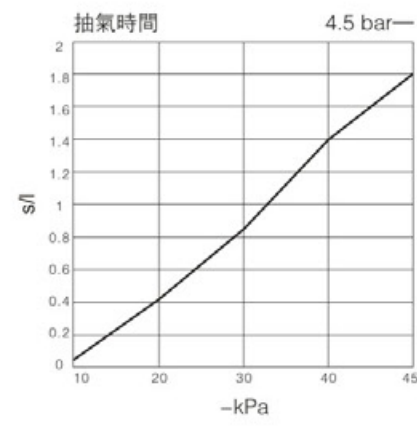
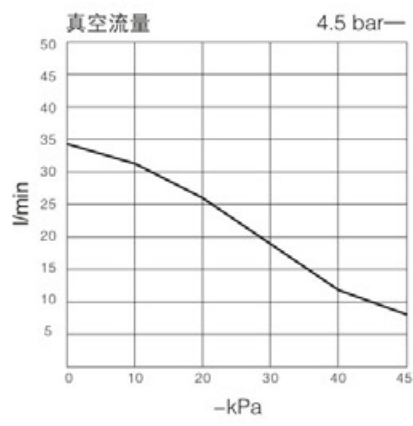

•FAZH13L

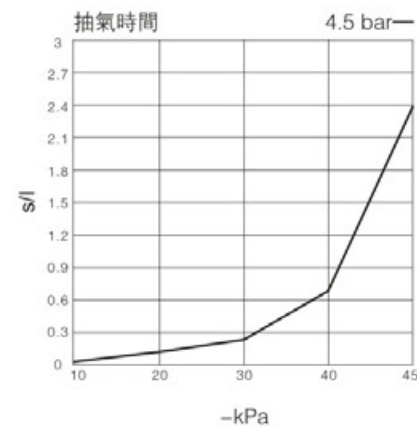
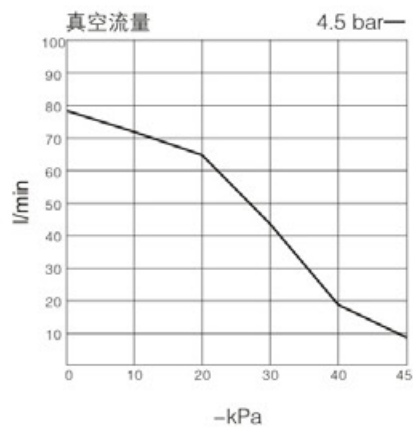

•FAZH15L

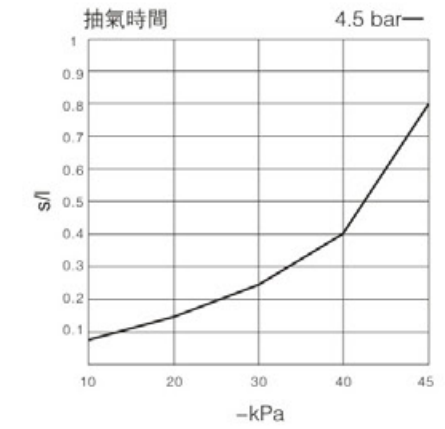
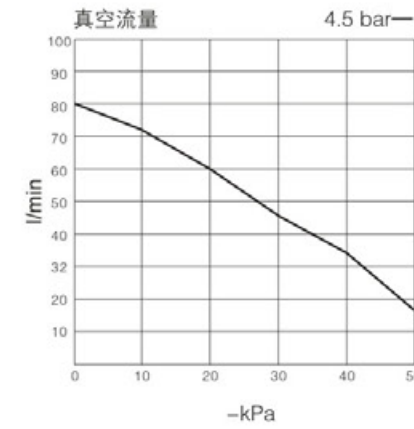

•FAZH18L

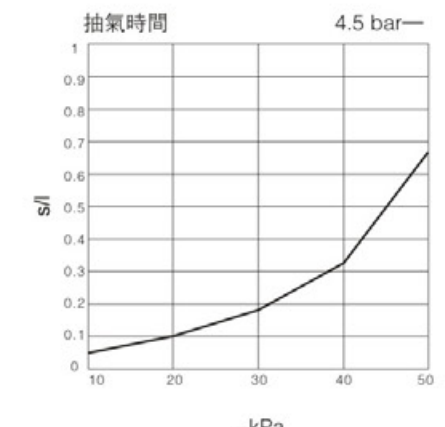
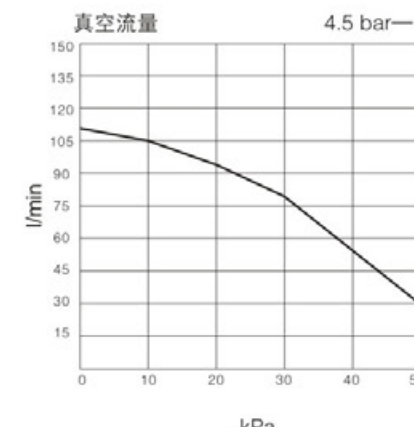

•FAZH20L

