

規格 Specification



內徑 Tube I.D. (mm)	32	40	50	63	80	100	125	160	200
動作形式 Motion Pattern	複動型 Double Action								
工作介質 Working Medium	空氣 Air								
固定型式 Mountings	基本型 /Basic type FA 型 /type FB 型 /type CA 型 /type CB 型 /type LB 型 /type TC 型 /type TC-M 型 /type								
使用壓力範圍 Operating Voltage Range	1 ~ 9.0 Kg/cm ²								
保證耐壓力 Ensured Pressure Resistance	13.5 Kg/cm ²								
使用溫度範圍 Operating Temperature Range	0 ~ 70°C								
使用速度範圍 Operating Speed Range	50 ~ 800 mm/s								
緩沖型式 Buffer Type	可調緩沖 Adjustable Buffer								
緩沖行程 mm Buffer Stroke	20			26			45		
配管口徑 Port Size	G1/8"	G1/4"	G3/8"		G1/2"		G3/4"		

*ASC、ASCJ 的固定型式為：FA、FB、LB、TC 和 TC-M 型。

*ASC、ASCJ mountings: FA、FB、LB、TC & TC-M type.

氣缸訂購代碼 Ordering Code

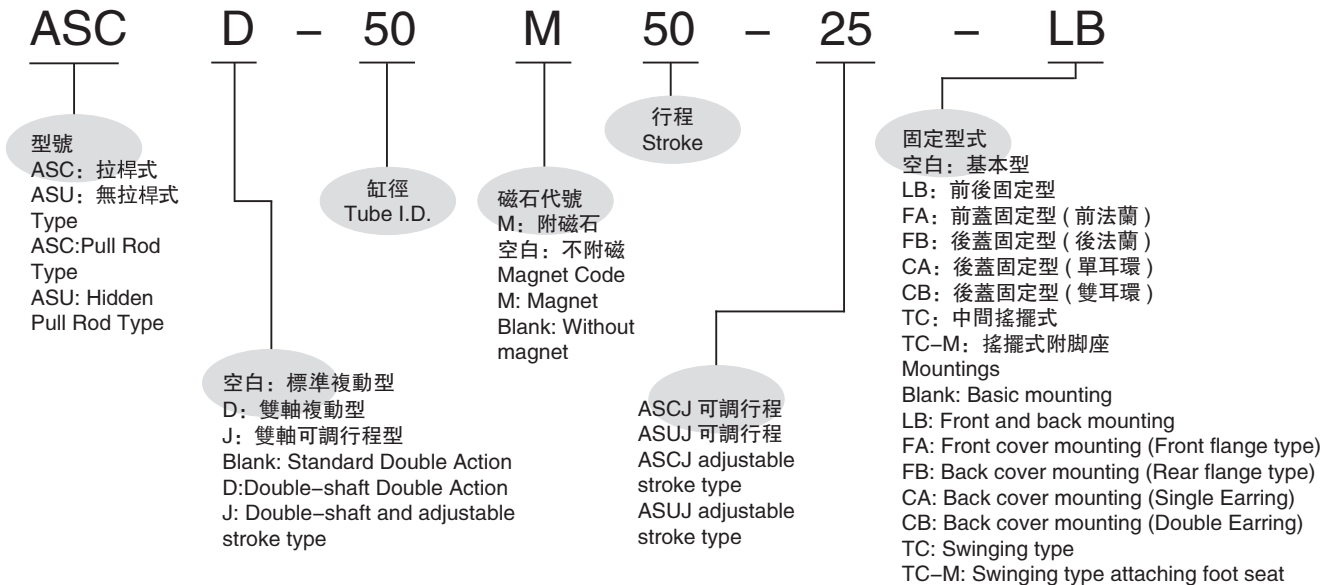

行程 Stroke

內徑 Tube I.D. (mm)	標準行程 Standard Stroke																最大行程 Max. Stroke	容許行程 Permissible Stroke					
32	25	50	75	80	100	125	150	160	175	200	250	300	350	400	450	500	1000	2000					
40	25	50	75	80	100	125	150	160	175	200	250	300	350	400	450	500	600	700	800	1200	2000		
50	25	50	75	80	100	125	150	160	175	200	250	300	350	400	450	500	600	700	800	900	1000	1200	2000
63	25	50	75	80	100	125	150	160	175	200	250	300	350	400	450	500	600	700	800	900	1000	1500	2000
80	25	50	75	80	100	125	150	160	175	200	250	300	350	400	450	500	600	700	800	900	1000	1500	2000
100	25	50	75	80	100	125	150	160	175	200	250	300	350	400	450	500	600	700	800	900	1000	1500	2000
125	25	50	75	80	100	125	150	160	175	200	250	300	350	400	450	500	600	700	800	900	1000	1500	2000
160	25	50	75	80	100	125	150	160	175	200	250	300	350	400	450	500	600	700	800	900	1000	1500	2000
200	25	50	75	80	100	125	150	160	175	200	250	300	350	400	450	500	600	700	800	900	1000	1500	2000

ASC

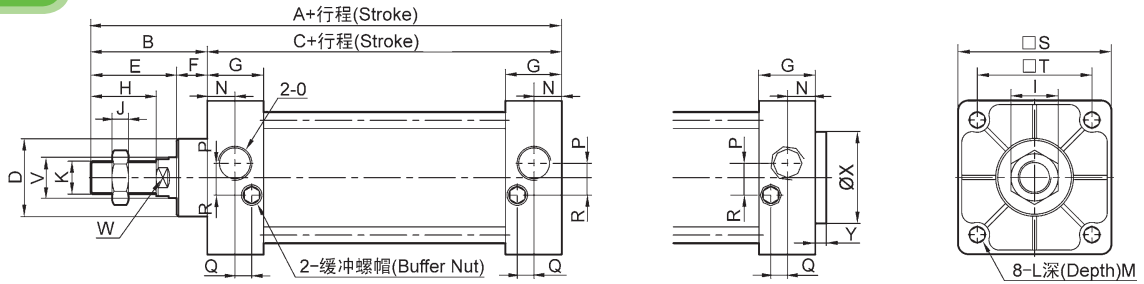

ASCD

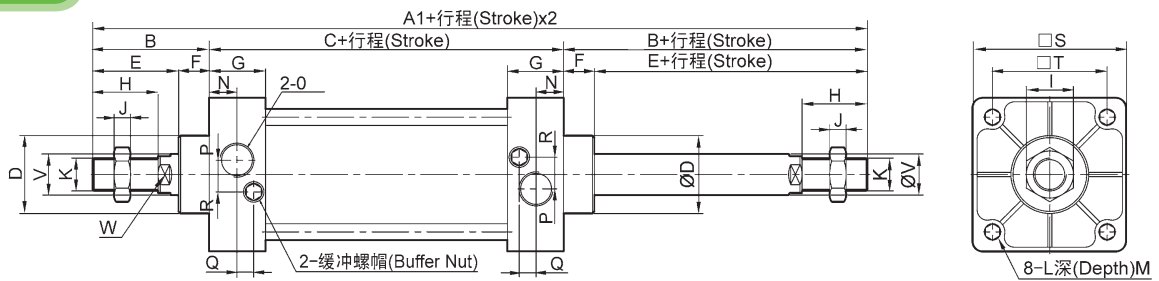

ASCJ

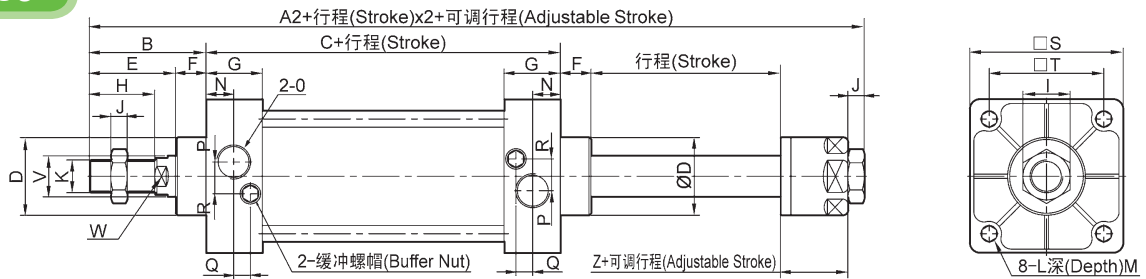

修正

符號 Symbol 內徑 Tube I.D.	A	A1	A2	B	C	D	E	F	G	H	I	J	K	L
32	140	187	182	47	93	25	32	15	27.5	22	17	6	M10 × 1.25	M6 × 1
40	142	191	185	48	93	30	34	15	27.5	24	19	7	M12 × 1.25	M6 × 1
50	150	207	196	57	93	36	42	15	27.5	32	23	8	M16 × 1.5	M6 × 1
63	153	210	199	57	96	36	42	15	27.5	32	23	8	M16 × 1.5	M8 × 1.25
80	183	258	243	75	108	47	54	21	33	40	26	10	M20 × 1.5	M10 × 1.5
100	189	264	249	75	114	47	54	21	33	40	26	10	M20 × 1.5	M10 × 1.5
125	226	/	/	104	122	55	70	34	33	54	40	10	M27 × 2	M12 × 1.75
160	291	/	/	123	168	62	91	32	50	72	55	18	M36 × 2	M16 × 2
200	347	/	/	167	180	80	112	55	50	72	55	18	M36 × 2	M16 × 2

符號 Symbol 內徑 Tube I.D.	M	N	O	P	Q	R	S	T	V	W	Z
32	9.5	13.5	G1/8	3.5	7.5	7	45	33	12	12	21
40	9.5	13.5	G1/4	6	8.2	9	50	37	16	14	21
50	9.5	13.5	G1/4	8.5	8.2	9	62	47	20	17	23
63	9.5	13.5	G3/8	7	8.2	8.5	75	56	20	17	23
80	11.5	16.5	G3/8	10	9.5	14	94	70	25	22	29
100	11.5	16.5	G1/2	11	9.5	14	112	84	25	22	29
125	15.5	16.5	G1/2	/	/	/	140	110	32	27	/
160	17.5	25	G1/2	/	/	/	180	140	40	36	/
200	17.5	25	G3/4	/	/	/	220	175	40	36	/



訂購代碼 Ordering Code

ASC - 50 - FA

ASC 標準氣缸
ASC Standard
Cylinder

缸徑
Tube I.D.

附件代號
Accessory Code

LB 腳架 Foot

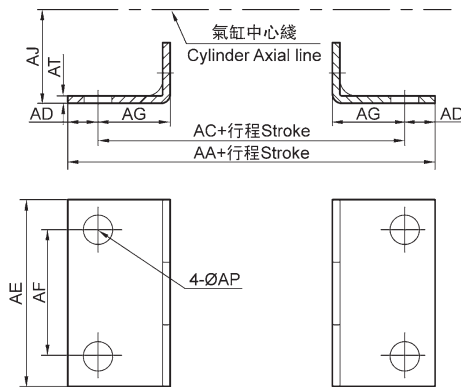

缸徑 Tube I.D.	32	40	50	63	80	100	125	160	200
符號 Symbol									
AA	153	169	173	184	200	210	249	328	380
AC	134	140	149	158	168	174	213	288	320
AD	9.5	14.5	12	12	16	18	18	20	30
AE	50	57	68	80	97	112	140	180	220
AF	33	36	47	56	70	84	90	115	135
AG	20.5	23.5	28	31	30	30	45	60	70
AJ	28	30	36.5	41	49	57	90	115	135
AP	9	12	12	12	14	14	16	18	22
AT	3.2	3.2	3.2	3.2	4	4	8	8	10

FA / FB 法蘭 Flange

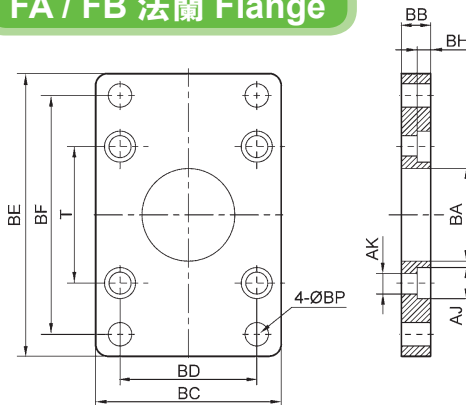

缸徑 Tube I.D.	32	40	50	63	80	100	125	160	200
符號 Symbol									
BA	28.3	32.3	38.3	338.3	347.3	347.3	56	63	81
BB	10	10	10	12	16	16	20	25	25
BC	47	52	65	76	95	115	140	180	220
BD	33	36	47	56	70	84	90	115	135
BE	72	84	104	116	143	162	224	280	320
BF	58	70	86	98	119	138	180	230	270
BH	6.5	6.5	6.5	8.5	10.5	10.5	15	20	20
AJ	10.5	10.5	10.5	13.5	16.6	16.6	19	25	25
AK	6.5	6.5	6.5	8.5	10.5	10.5	12.5	16.5	16.5
BP	7	7	9	9	12	12	16	18	22
T	33	37	47	56	70	84	110	140	175

CA 單耳環 Hinge

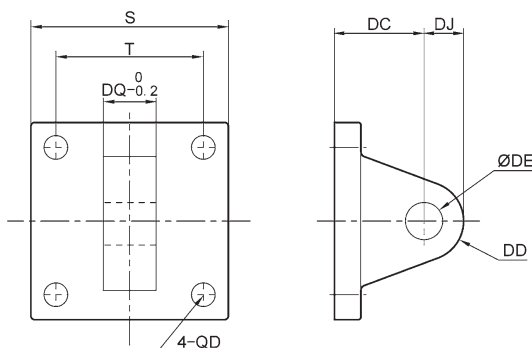

缸徑 Tube I.D.	32	40	50	63	80	100	125	160	200
符號 Symbol									
S	48	50	62	75	94	112	140	180	220
T	33	37	47	56	70	84	110	140	175
DC	34	34	34	34	48	48	50	55	60
DD	14	14	15	15	20	20	25	30	30
DE	12	14	14	14	20	20	25	30	30
DJ	14	14	15	15	20	20	25	30	30
DQ	16	20	20	20	32	32	70	90	90

CB 雙耳環 Hinge

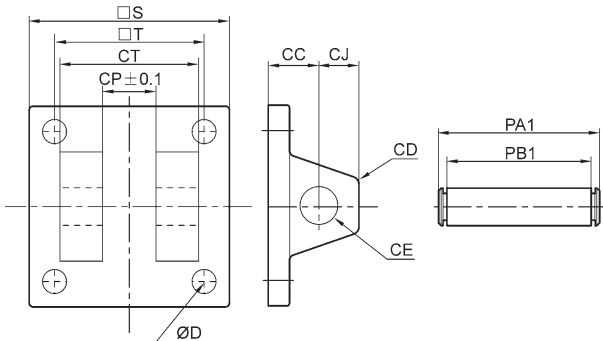

缸徑 Tube I.D. 符號 Symbol	32	40	50	63	80	100	125	160	200
CC	19	19	19	19	32	32	50	55	60
CD	5	5	3	3	8	8	25	30	30
CE	12	14	14	14	20	20	25	30	30
CJ	13	13	15	15	21	21	25	30	30
CP	16.3	20.5	20.3	20.3	32.3	32.3	70	90	90
CT	32	44	52	52	64	64	120	160	160
PAI	41	51.8	60.3	60.3	73.8	73.8	130	170	170
PBI	33.5	45.8	54	54	65.5	65.5	121.5	161.5	161.5
S	48	50	62	75	94	112	140	180	220
T	33	37	47	56	70	84	110	140	175

TC 中擺 Center Trunion

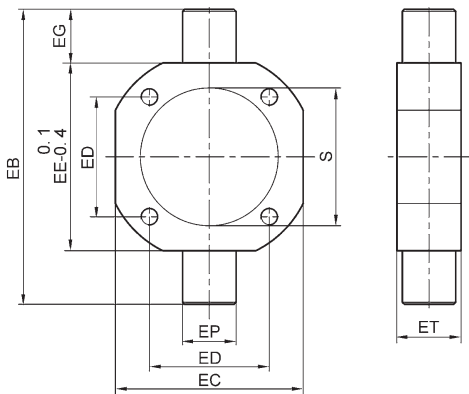

缸徑 Tube I.D. 符號 Symbol	40	50	63	80	100	125	160	200
EB	113	126	138	164	182	210	264	336
EC	63	76	88	114	132	160	200	245
ED	37	47	56	70	84	110	140	175
EE	63	76	88	114	132	160	200	245
EG	25	25	25	25	25	25	32	35
EP	25	25	25	25	25	30	32	32
ET	30	30	30	35	40	38	38	52
S	45.5	55.5	68.5	87.5	107.5	134.5	172.5	212.5

Y 接頭 / Y Connector

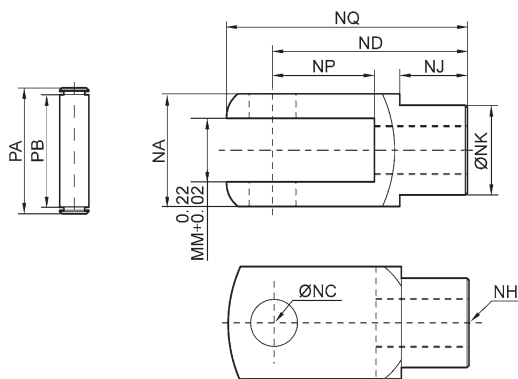

I 接頭 / I Connector

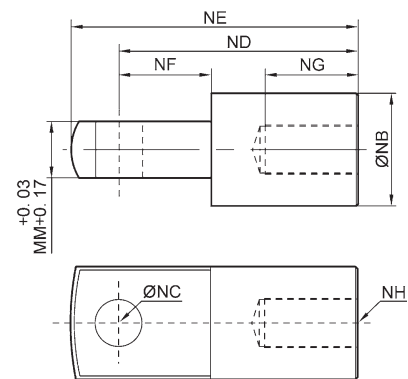

缸徑 Tube I.D. 符號 Symbol	NA	NB	NC	ND	NE	NF	NG	NH	NJ	NK	NM	NP	NQ	PA	PB
32	19	20	10	40	52	15	20	M10×1.25	12	18	10	20	52	26.2	20
40	25.4	24	12	48	67	24	20	M12×1.25	20	23	12	24	62	32.8	26.5
50	32	32	16	64	89	32	23	M16×1.5	22	30	16	32	83	39.3	33
63	32	32	16	64	89	32	23	M16×1.5	22	30	16	32	83	39.3	33
80	44.4	40	20	80	112	40	30	M20×1.5	30	39	20	40	105	53.3	45
100	44.4	40	20	80	112	40	30	M20×1.5	30	39	20	40	105	53.3	45

PHSA 魚眼接頭

PHSA Universal Piston Rod Eye

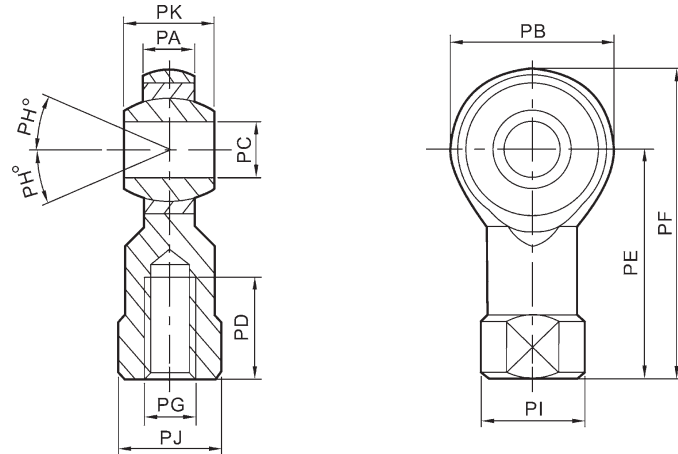

符號 Symbol 缸徑 Tube I.D.	PA	PB	PC	PD	PE	PF	PG	PH	PI	PJ	PK
32	11	26	10	20	43	56	M10 × 1.25	13	19	17	14
40	12	32	12	24	50	66	M12 × 1.25	13	22	19	16
50	15	40	16	28	64	84	M16 × 1.5	15	27	22	21
63	15	40	16	28	64	84	M16 × 1.5	15	27	22	21
80	18	46	20	35	77	100	M20 × 1.5	15	34	30	25
100	18	46	20	35	77	100	M20 × 1.5	15	34	30	25

FDJT 浮動接頭

FDJT Piston Floating Jiont

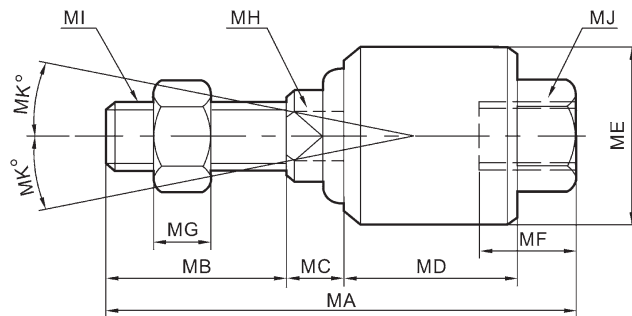

符號 Symbol 缸徑 Tube I.D.	MA	MB	MC	MD	ME	MF	MG	MH	MI	MJ	MK
32	58	22	7	21	26	11.5	7	10	M10 × 1.25	M10 × 1.25	12
40	58	22	8	21	28	11.5	8	12	M12 × 1.25	M12 × 1.25	12
50	90	27	10	41	44.5	20	10	17	M16 × 1.5	M16 × 1.5	7
63	90	27	10	41	44.5	20	10	17	M16 × 1.5	M16 × 1.5	7
80	102	29	13	46	53	24	13	22	M20 × 1.5	M20 × 1.5	10
100	102	29	13	46	53	24	13	22	M20 × 1.5	M20 × 1.5	10